

FORM DESIGNS AUSTRALIA PTY LTD

COMPANY PROFILE

Part 1: Company Profile
Part 2: Services and Experience



DESIGN. CREATE. SURPASS.





PART ONE: COMPANY PROFILE

CAPABILITY STATEMENT

FORM DESIGNS AUSTRALIA PTY LTD

COMPANY PROFILE

- [01] **Introduction and Overview**
- [02] **Mission Statement & Our Why**
- [03] **Business Profile**
- [04] **Management Profiles**
- [05] **Contact Details**

[01] Introduction and Overview

Form Designs is an industrial design and engineering company, located in Bibra Lake, Western Australia.

First established in 1982 in Johannesburg, South Africa, by Edward and Sharon Khoury, Form Designs relocated to Perth, Western Australia in 1996.

Our team are innovation specialists trained to design functional, beautiful products with a strong awareness of our fragile environment and an appreciation for quality and longevity. We are driven to establish new highs in safety and reliability and recognise that ultimately products should sell.

*“DESIGNING FOR LIFE IS EXCEPTIONAL,
EXCEPTIONAL DESIGN IS FOR LIFE”*

- EDWARD KHOURY 2022



MISSION STATEMENT

To lead design by example,

To be responsible and to design with awareness of our environment, society and sustainability,

To form lasting relationships with our clients and suppliers, and

To become an extension of their companies, deliver desirable, marketable, excellent products and above all to innovate beyond expectations.

TO DESIGN, CREATE, AND SURPASS.

OUR WHY

Our service is unique and if we take on a project it is because we really believe in it.

You don't have to be a wealthy, successful corporation you just have to have a good idea.

Our goal is to change the status quo by designing things that change lives for the better.

We are not the biggest firm in town, that is not our focus. Our focus is always to be the best.

We have a strong awareness of our environment and a respect for life and when we design we make this our responsibility.

We are not driven by wealth, wealth is a by-product of what we do.

Design, Create, **Surpass.**



[03] Business Profile

HUMAN RESOURCES

Managing Director: Edward Khoury

Operational Director: Sharon Khoury

General Manager: Victoria Khoury

Studio Manager: Ross Khoury

Organisational Teams:

- Industrial Design and Engineering: Product Development
- Industrial Design and Engineering: Engineering Drafting
- Graphic Design and Advertising
- Project Management
- Marketing & PR
- Accounts
- Administration

Number of Employees:

- 14+



[04] Management Profile

EDWARD KHOURY, MANAGING DIRECTOR

Edward qualified as an Industrial Designer in 1983 after serving two (2) years in the South African Defence Force in the Department of Director Force Training. In 1982 he founded Form Designs to pursue his passion for design and innovation and within 14 years led the largest Industrial Design company in Johannesburg, South Africa. In 1994 Edward obtained his National Higher Diploma in Industrial Design (which was the highest qualification obtainable in South Africa, at the time) and lectured part time at the school of Art and Design in Johannesburg. In 1996 Edward relocated to Perth, Western Australia and re-established Form Designs (Australia) with his wife, Sharon, and within a few years became one of the largest Industrial Design consultancies in Perth. Form Designs is now considered a leader in the Perth and wider Australian market for innovation and design.

In Edward's 40 years experience, he has established strong relationships with clients and manufacturers around the world. Some of his clients include DeLonghi in Japan, Phillips in Holland, Telkom Group, 3M and Symo Corporation in South Africa, Hafele and Rommelsbacher in Germany and Strix in the UK.

Amongst his local portfolio is the Marine Infrastructure Project for Global Marine Enclosures, an industrial design partnership with Calytrix Technologies, a new innovation for Woodside, the Lions Eye Institutes' Portable Eye Imaging Device which was used for testing in the Space Station, the Schuetz DSL Dip Tube, ToLife Technologies Lice Comb Technology, 300K Enterprises' Light Fitting Adaptor, the Uccello Kettle, Globaltech Corporation's Pathfinder, a number of designs for Barrett Communications, Tieline's ViA Portable Codec, Louver Designs for Arcadia and Intium Energy's Conveyor Belt Monitor, to name a few.

Edward has registered over 500 patents and designs on projects over the past four decades, which is testament to his ability to innovate.



[04] Management Profile

- Managing Director: Form Designs Australia Pty Ltd
- Managing Director: Global Marine Enclosures Pty Ltd
- Practicing Member: Design Institute of Australia (#5598)
- Industrial Designer: NHDID, Technikon Witwatersrand School of Art and Design, South Africa: 1994
- PhD Candidate: Industrial Design, Faculty of Arts & Design, University of Canberra: expected completion 2024
- Holder of in excess of 500 patents as Inventor or Co-Inventor
- Ernst & Young Business Personality of the Week Award:1993
- Good Design Award Winner: 2010, 2012, 2015, 2017, 2018, 2020, 2021
- Good Design Award Chicago: 2021 & 2022
- Australia By Design Innovation Series Judge: 2018-2022
- Published in Curve Magazine: Issue 36 2011



[04] Management Profile

SHARON KHOURY, OPERATIONAL DIRECTOR

- Co-Founder & Operational Director of Form Designs Australia Pty Ltd.
- 40 years serving as Director.
- 40+ years specialising in Project Management.
- Co-ordinated projects for Telkom, 3M, Phillips, Schuetz DSL, Barrett Communications, Tolife Technologies, McMahon, Sutherland Mining, Rommelsbacher, Telstra & NBN, South African Post Office as well as currently Calytrix Technologies, to name a few.



[04] Management Profile

ROSS KHOURY, STUDIO MANAGER

- 8 Years Industrial Design Experience working under the Director's at Form Designs.
- Holder of 40 Patents
- Has capability to develop products in all disciplines that Form Designs is involved in.



VICTORIA KHOURY, GENERAL MANAGER

- 12 Years Experience working under the Director's at Form Designs in the fields of Administration, Accounts and Project Management.
- Cert IV in Business Administration



[05] Contact Details



Managing Director:

Edward Khoury

(08) 9418 3311

edward@formdesigns.com.au



Operational Director:

Sharon Khoury

(08) 9418 3311

sharon@formdesigns.com.au



General Manager:

Victoria Khoury

(08) 9418 3311

victoria@formdesigns.com.au



Studio Manager:

Ross Khoury

(08) 9418 3311

ross@formdesigns.com.au



PART TWO: SERVICES AND EXPERIENCE

CAPABILITY STATEMENT

FORM DESIGNS AUSTRALIA PTY LTD

SERVICES AND EXPERIENCE

- [06] **Core Competencies and Original Achievement**
- [07] **Design Service**
- [08] **Clients by Industry/Sectors**
- [09] **Testimonials**

[06] Core Competencies & Original Achievements

Form Designs Australia continues to adapt its service to the rapidly shifting landscape of new product development. Over the years the company has added services to complete the new product development cycle, from initial concept through to production and marketing.

The most recent shift into engineering drafting reflects the constantly evolving nature of the Form Designs business, and builds upon the company's core competencies of computer modelling and design engineering.

We aim to continue to evolve our services to bring our design competencies to new industries and markets.

Form Designs has received a number of awards for its exceptional design service.



AUSTRALIAN GOOD DESIGN AWARD OF THE YEAR



AUSTRALIAN GOOD DESIGN AWARD SUSTAINABILITY



AUSTRALIAN GOOD DESIGN AWARD BEST IN CLASS



AUSTRALIAN GOOD DESIGN AWARD GOLD



AUSTRALIAN GOOD DESIGN AWARD WINNER



WINNER CHICAGO GOOD DESIGN AWARDS



TROPICAL NORTH QUEENSLAND INNOVATION AWARDS

[06] Core Competencies & Original Achievements

Tieline: G5 VIA



Tieline
The Codec Company



Tieline
The Codec Company



Tieline
The Codec Company

- Radio World US Best of Show (NAB) 2016 • Radio World International (Europe) Best of Show Awards (IBC) 2016

[06] Core Competencies & Original Achievements

Calytrix Technologies Pty Ltd



[06] Core Competencies & Original Achievements

Smart-I (Used by NASA)



[06] Core Competencies & Original Achievements

Lion's Eye: Portable Eye Imaging Device

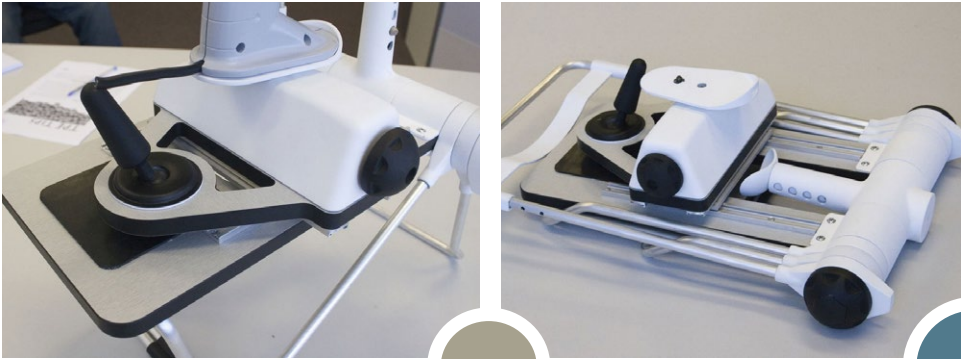

[06] Core Competencies & Original Achievements

Globaltech Pathfinder Design



[06] Core Competencies & Original Achievements

The Fly6: Cycling Camera

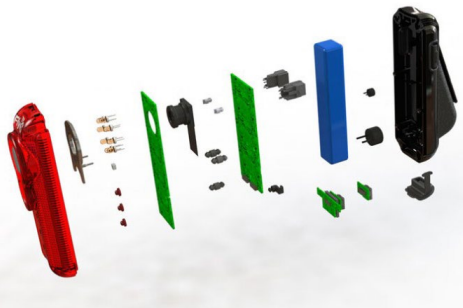

[06] Core Competencies & Original Achievements

Cyclevision: Twin-Camera Helmet

Winner Tropical North
Queensland Innovation
2016

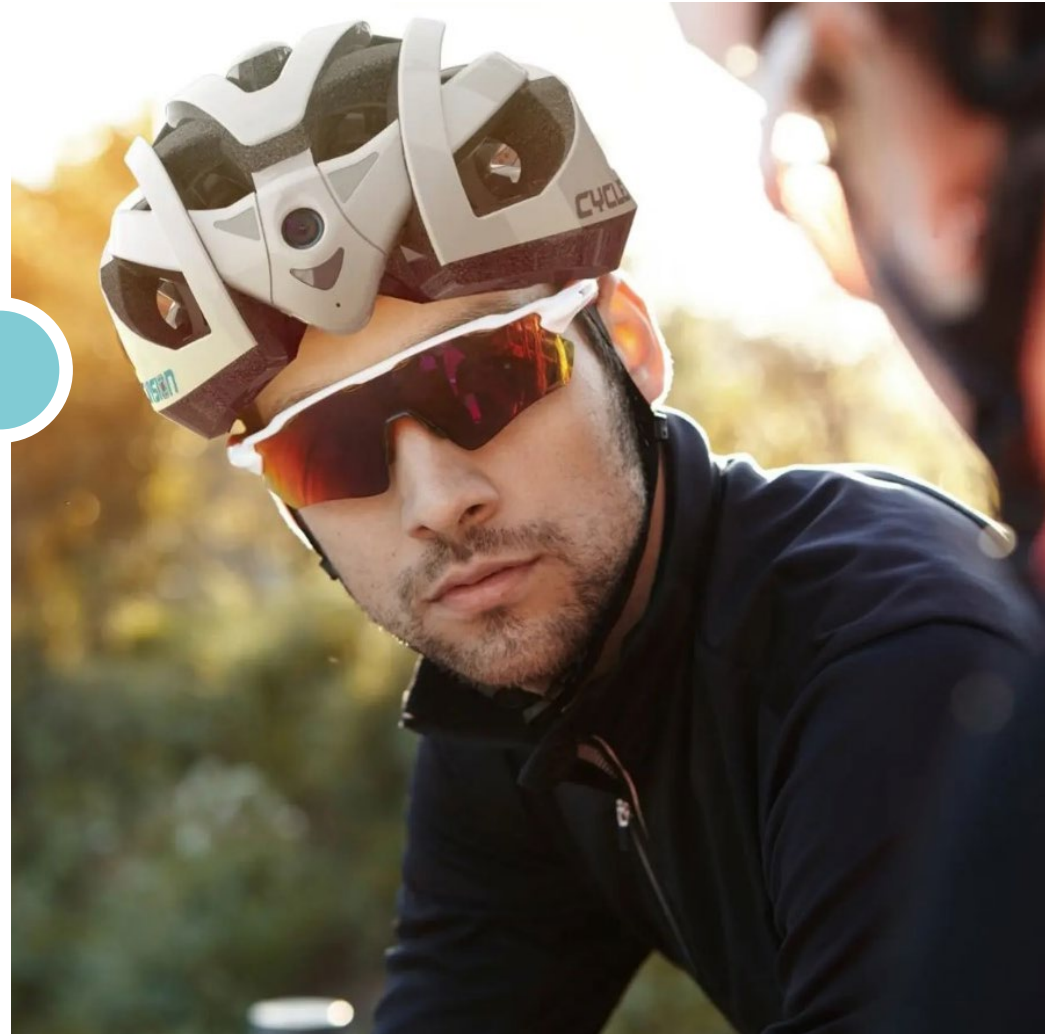

[06] Core Competencies & Original Achievements

Styleware Pty Ltd



[06] Core Competencies & Original Achievements

Global Marine Enclosures Pty Ltd

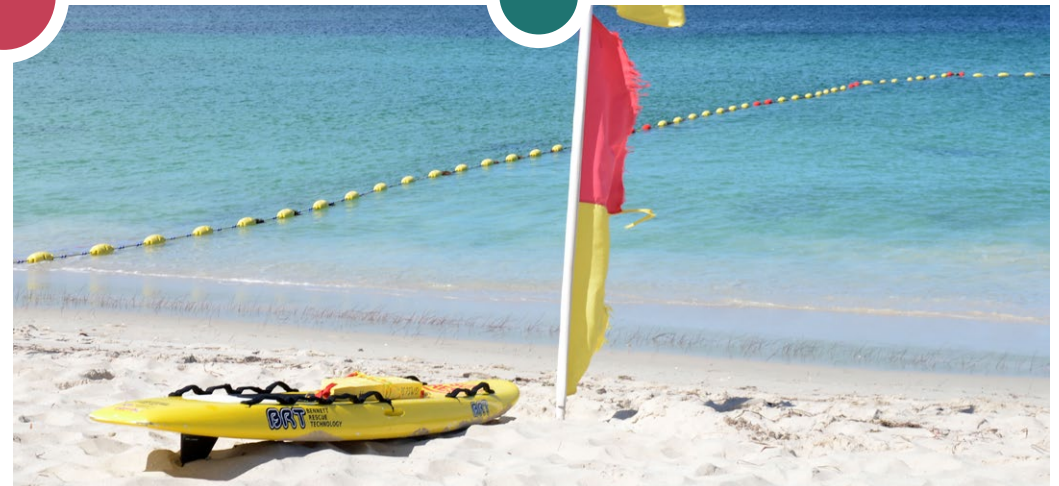

[06] Core Competencies & Original Achievements

Blazaball Pty Ltd



[06] Core Competencies & Original Achievements

Shoppacart Pty Ltd

Winner Chicago
Good Design Awards
2021

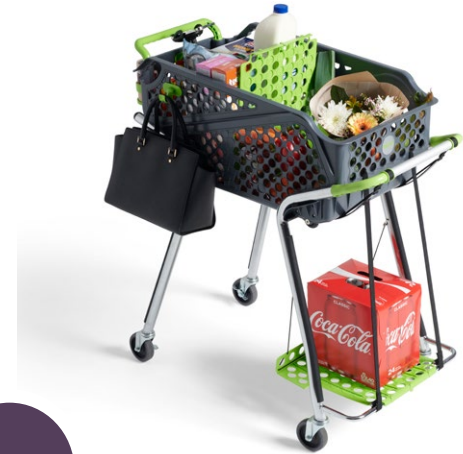

[06] Core Competencies & Original Achievements

Kruzi Stroller Highchair

Winner Chicago
Good Design Awards
2022



[07] Design Services

BRIEF DEVELOPMENT

At Form Designs we consider the design brief to be the most important phase of the development process. This is where the direction, parameters and desires for the outcomes for a project stems from. We take the brief very seriously and we try to deliver without deviation so that we achieve according to the requirements.



[07] Design Services

CONCEPTUALISATION

Concepts are usually developed through sketches or 3D hand-made models prior to any 3D modelling on computer so that the technical, aesthetic and functional criteria can be resolved as soon as possible in the development process. At Form Designs we consider function first but we have insight to develop products that have significant aesthetic value.

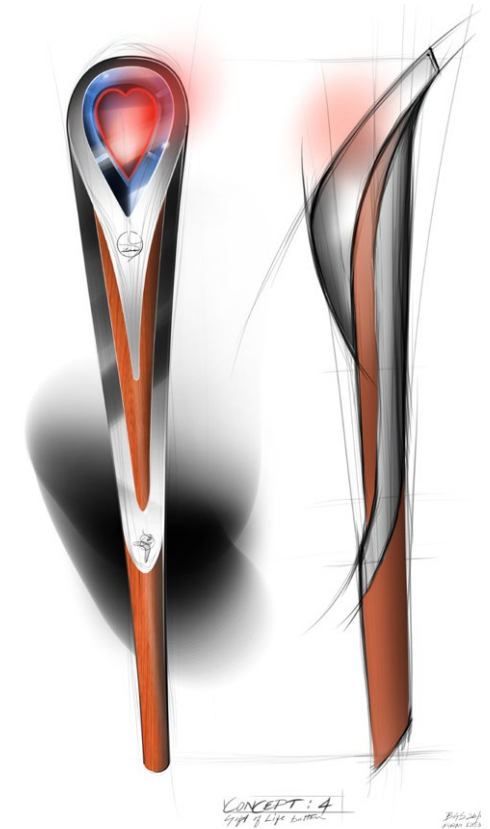
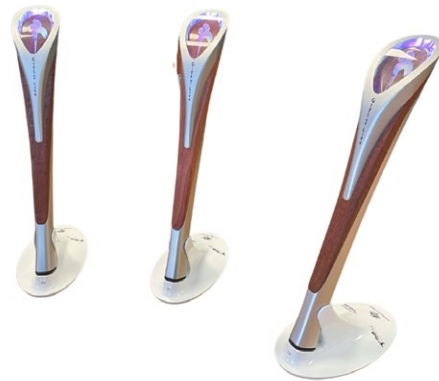

[07] Design Services

ENGINEERING FOR MASS PRODUCTION

Form Designs concentrates on structural and mechanical engineering solutions. Built upon its long history of providing innovative and award winning products, Form Designs offers engineering solutions for all projects, no matter how large or small. Many clients appreciate the professionalism and diligence of our team, and the structured workflow method that allows projects to be completed on time, and on budget. Our team has excellent skills in communicating with the client and understanding the project requirements, which avoids costly re-workings. Our clients often contract projects to Form Designs because of our innovative culture which brings a fresh approach to problems, and layouts can be modelled and seen in virtual reality before they are executed.



[07] Design Services

PROJECT MANAGEMENT

Form Designs takes a very formal and professional approach to design and drafting projects: we believe that good work structure is the key to success. A well planned and organised project will allow the design process to run smoothly and allow deadlines to be met. In most cases we manage projects from start to finish, but we can take over existing projects if required.

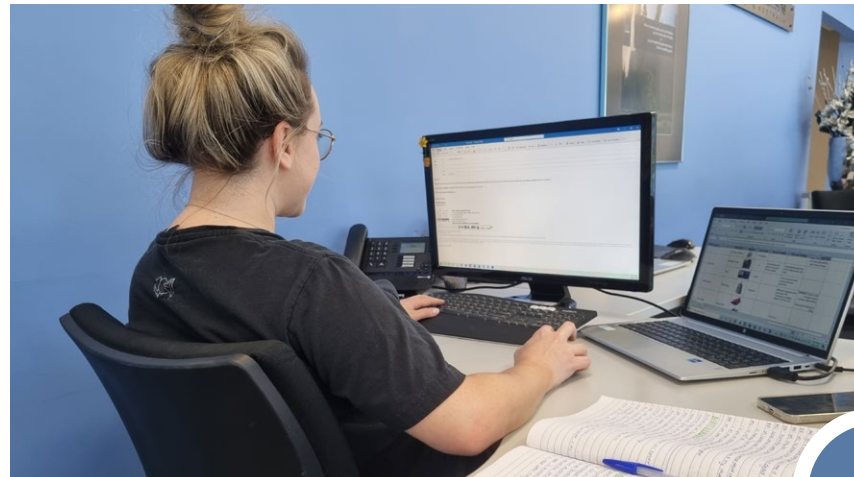



[07] Design Services

DESIGNING / 3D MODELLING

Once the design concept has been selected and approved, our team will build a virtual 3D model using the latest computer-aided design software. These 3D models help to clearly understand the product and its function, before embarking on the manufacture of the proposed design.

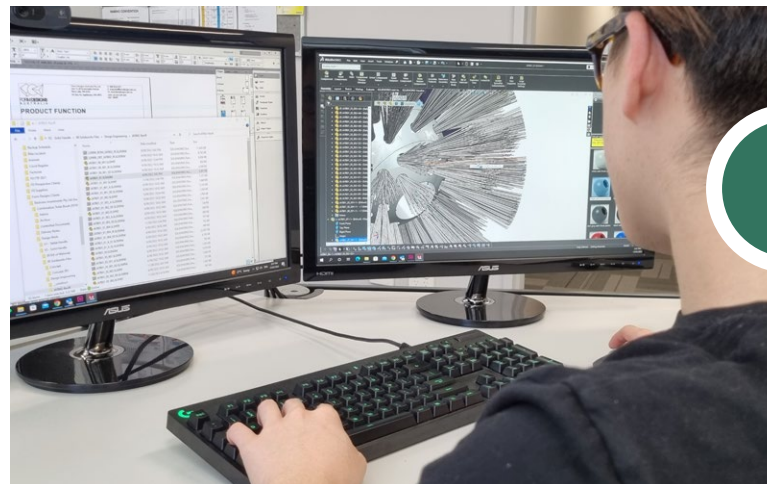
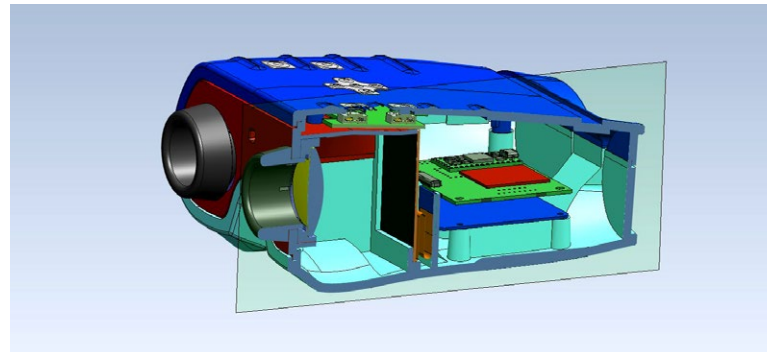

3D SOLIDWORKS

[07] Design Services

2D ENGINEERING DRAWING / DESIGN DOCUMENTATION

2D engineering drawings are generated for each component to fully and clearly define requirements such as materials and tolerances, capturing all geometric features for engineered parts. This area is the core business of Form Designs and the thorough approach taken by the design team will allow your project to be completed without any unforeseen interruptions.

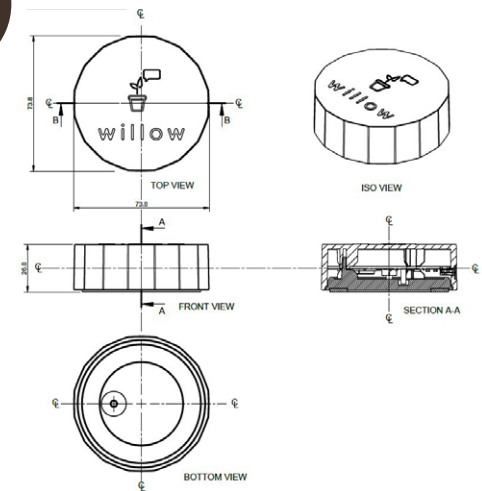
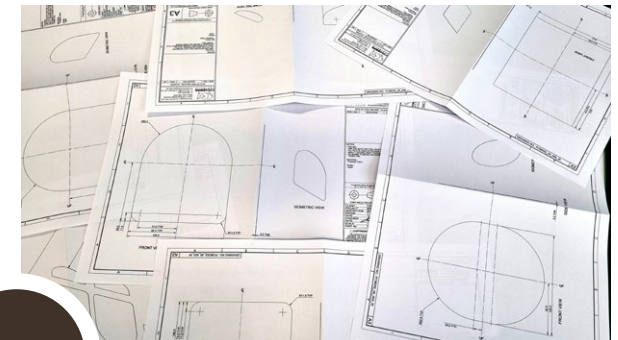
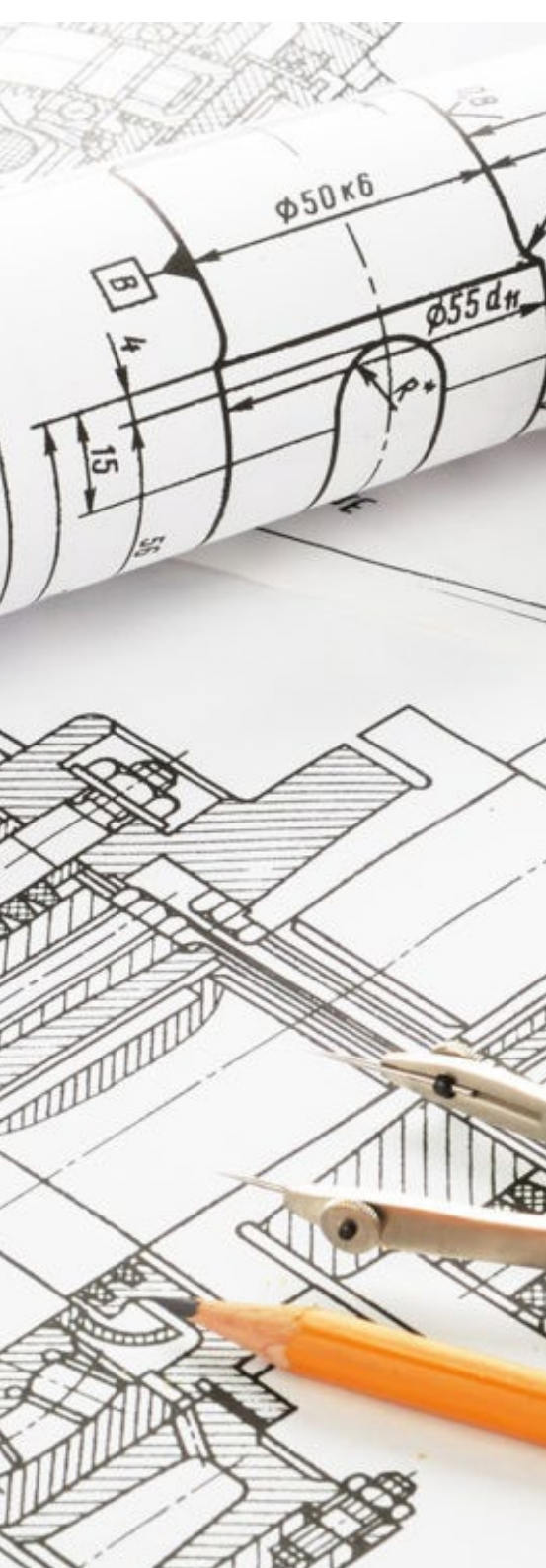



[07] Design Services

TESTING AND ENGINEERING COMPLIANCE

At Form Designs, we ensure that our designs and products are produced to the highest quality. Every product we engineer undergoes a thorough quality control checklist which is generated by Form Designs and tested by qualified QC personnel in the related manufacturing industry. In many cases this includes dealing with authorities in different genres of engineering, including structural and civil engineers together with testing authorities such as ITS, SGS, and KEMA covering testing for C-Tick, CE, EMC and UL.

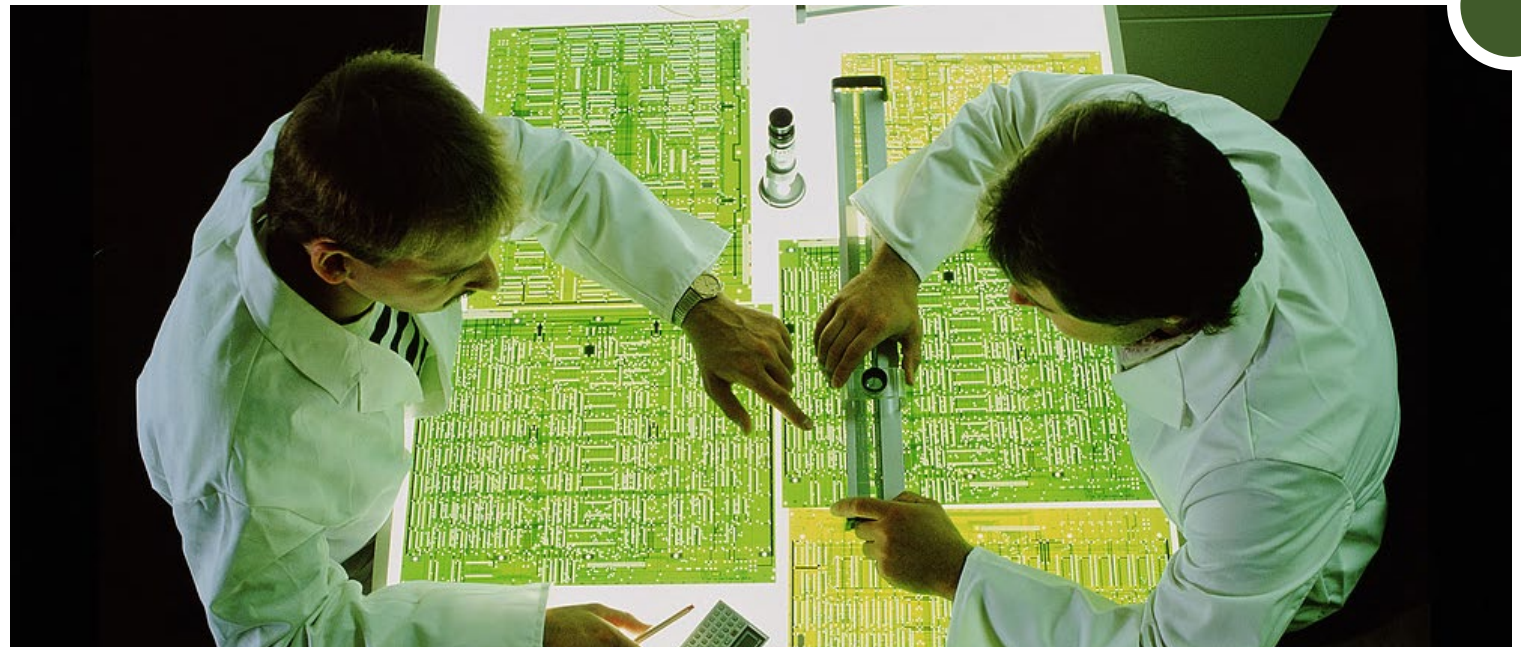

[07] Design Services

RAPID PROTOTYPING AND 3D PRINTING

Form Designs have the latest and most up-to-date 3D Printing Facilities in-house with hand-working equipment to compliment and finish the designs that have been created. The prototyping approach is systematic and organised and the finish and quality of prototypes are of the highest standard. Form Designs are able to produce low-quantity production of the designs that we have developed.

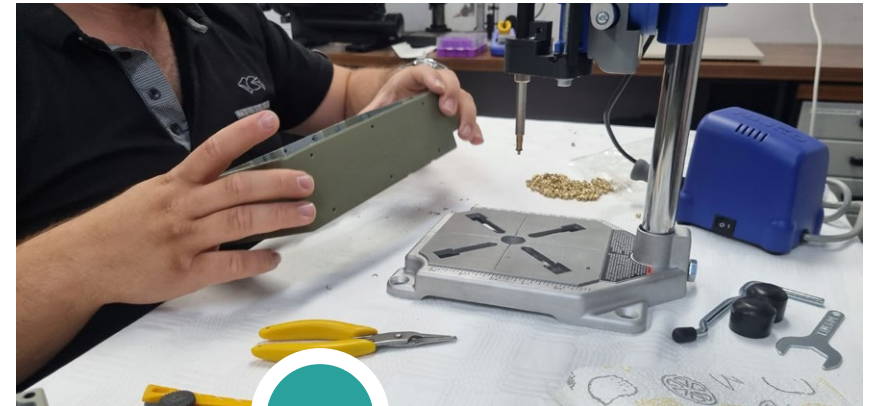

[07] Design Services

PRODUCTION AND FACTORY SOURCING

Over the past four (4) decades, Form Designs has established strong working relationships with manufacturing companies locally and abroad in metal fabrication, plastics and electronics. These close relationships help to effectively select the ideal manufacturer for your project. We are able to source new manufacturers if required or collaborate existing manufacturer's known to our clients.



[07] Design Services

INFORMATION AND GRAPHIC DESIGN

Form Designs' Graphics Department complements our Product Development program by including Corporate Identity and Branding Services, Packaging and Instruction Manual design as well as developing an online presence in the market including website development, user interface graphics and promotional material.

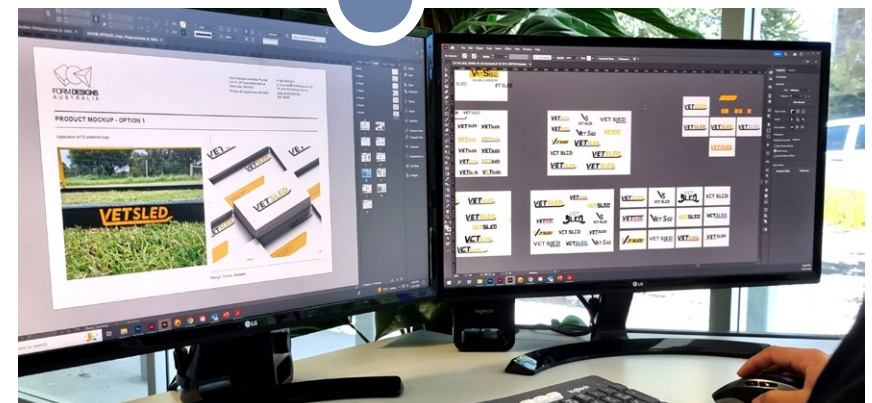
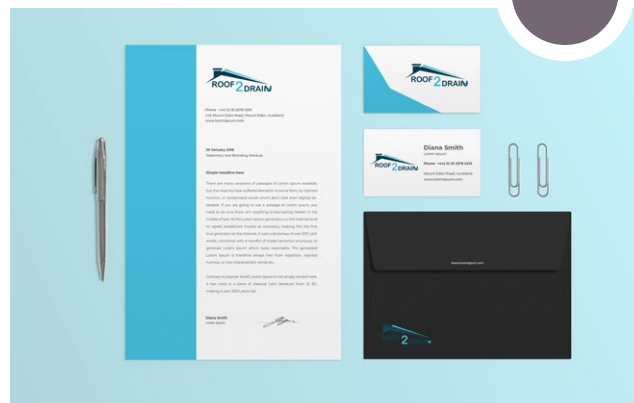

[08] Clients by Industry/Sector

Over the past 40 years, Form Designs has had the opportunity to work with hundreds of clients across a variety of different projects. Form Designs began by establishing a significant market presence in South Africa after working for some major telecommunications clients, and has since expanded to work with major companies in a number of different industries around the world. Below is a list of some of the more notable clients and projects that have been undertaken by Form Designs.

MINING AND RESOURCES

- Schuetz DSL (Australia)
- Sandvik Mining and Construction
- Globaltech Corporation
- Intium Solutions
- Immersive Technologies
- Thistle Fabrication
- Sutherland Mining
- AECI Explosives

RAIL AND FREIGHT

- Pacific National
- Cargo

COMMUNICATION

- Telkom Group
- Barrett Communication
- RCS Communication
- Telstra & NBN

SCIENCE AND MEDICAL

- Medsales
- Tolife Technologies
- Lions Eye Institute

CONSTRUCTION / INDUSTRIAL

- Relocatables Australia
- Global Marine Enclosures

TECHNOLOGY / APPLIANCES

- Calytrix Technologies
- DeLonghi
- Phillips
- Rommelsbacher
- Hafele
- TAB
- 3M
- **CONSUMER**
- Gift of Life
- Cyclevision



[09] TESTIMONIALS

Calytrix Technologies Pty Ltd

“As we set out on an ambitious new project to complete the delivery of six new product types concurrently we were in need of an experienced group who could not only provide design support, but who could work with us as a partner to identify and weigh up different approaches, and adapt to the evolving needs that come in any new endeavour. In working with Form we found such a group. They have been professional and thorough, but also personable and invested in the success of the project from the beginning. They have worked diligently with our internal team and on-site with our customers, always inspiring confidence. We would not have been able to achieve what we have without the hard work and dedication of Ross, Tony, Victoria, Ed and the team, and we look forward to a continued partnership into the future.”

Tim Pokorny, CTO of Calytrix Technologies



[09] TESTIMONIALS

Steadyrack Pty Ltd

"They were very supportive and encouraging and gave us sound advice on where we could take our invention and what we could do. We found their honesty and integrity to be outstanding and we have in fact engaged them to design another bike storage product for us to expand our range."

David & Janine Steadman, Founder of Steadyrack

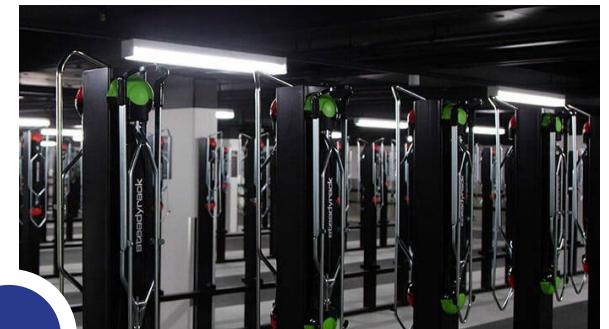

[09] TESTIMONIALS

Styleware Pty Ltd

"Thank you so much to the team at Form Designs for helping us to realise our dream. With a clear concept and plenty of drive the team were able to recognise the potential for Styleware and help to turn our Nesting Bowls Collection into a physical reality. Their knowledge and experience were invaluable to the success of the project, culminating in our recent Good Design Australia 2021 Gold Winner Award. On a personal level we have loved getting to know and work with this wonderful family run business, with the Khourys providing a personable yet professional service. Thank you to Ed, Sharon, Victoria, Ross and Jess for all their hard work. We look forward to working on future projects together"

Arabella & Matthew Selby, Founder of Styleware



Edward Khoury
Managing Director
Unit 11, 20 Sustainable Ave
Bibra Lake, WA 6163
(08) 9418 3311
edward@formdesigns.com.au

www.formdesigns.com



DESIGN. CREATE. SURPASS.